

Installation Instruction

Three Flow Kitchen Faucet

Before Your Installation

Check to make sure you have the following parts indicated below:

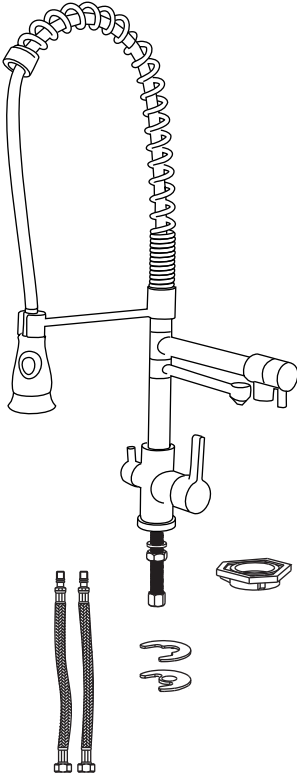

Tools You Will Need



Adjustable wrench

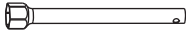

Spanner
(supplied)

Replacement Parts

Keep this manual for ordering replacement parts.

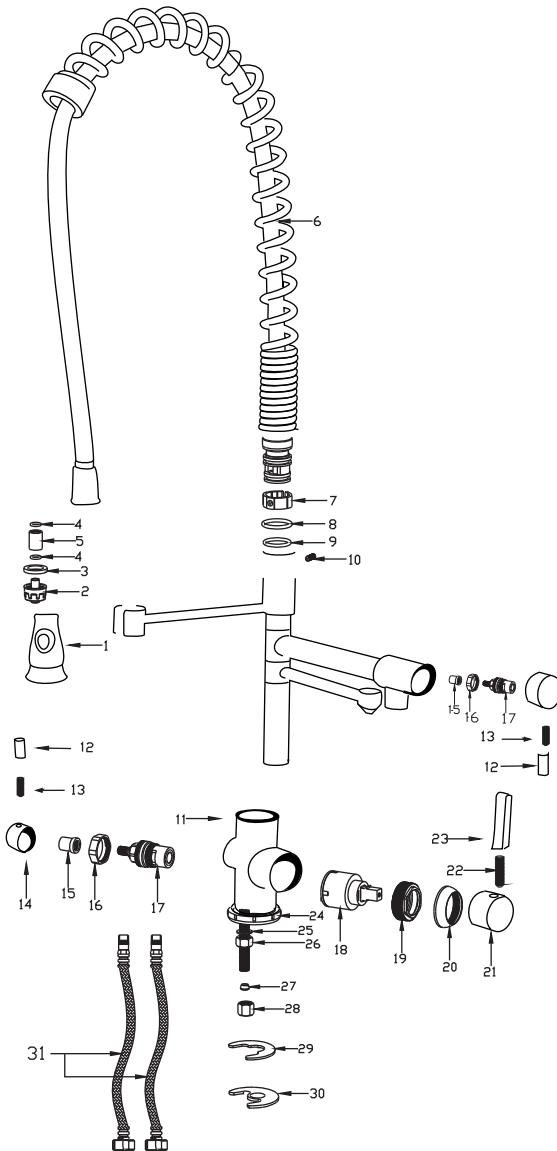

NO	NAME
1.	Aerator holder
2.	Aerator
3.	O-ring
4.	Sealing plate
5.	O-ring
6.	Spout
7.	Plastic cover
8.	O-ring
9.	O-ring
10.	Screw
11.	Faucet body
12.	Handle knob
13.	Screw
14.	Handle body
15.	Universal fixed cover
16.	Lock nut
17.	Cartridge
18.	Cartridge
19.	Lock nut
20.	Cartridge holder
21.	Handle body
22.	Screw
23.	Handle knob
24.	Bottom gasket
25.	Washer
26.	Lock nut
27.	Retainer ring
28.	Nut
29.	Rubber gasket
30.	Stainless steel gasket
31.	Hose

Product Dimension Drawing

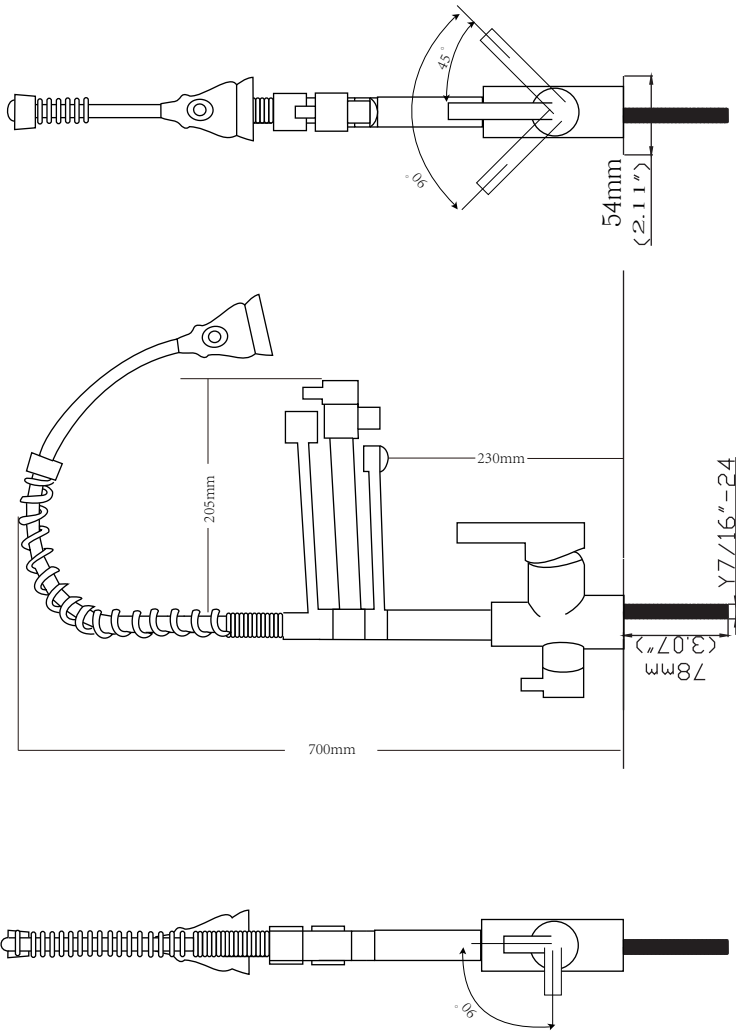

Faucet Installation Procedures

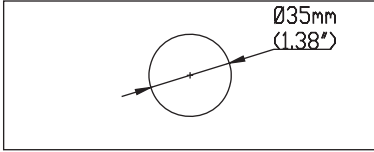

Step ①

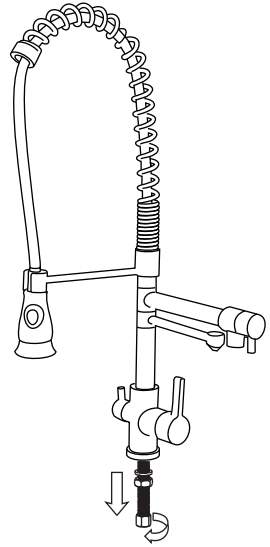

Step ②

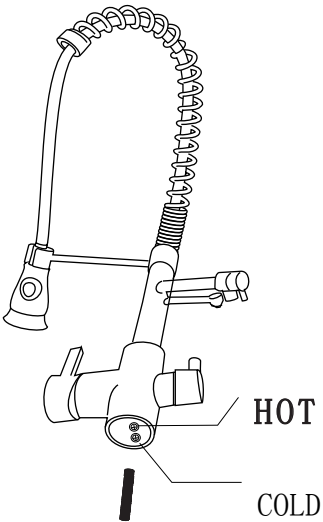

Step ③

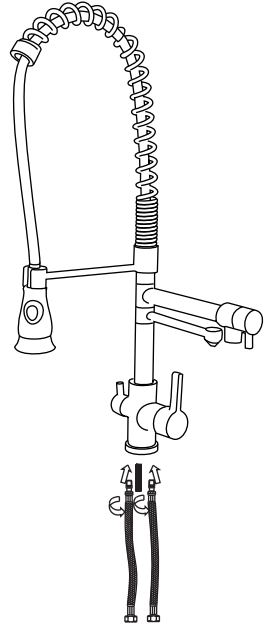

Step ④

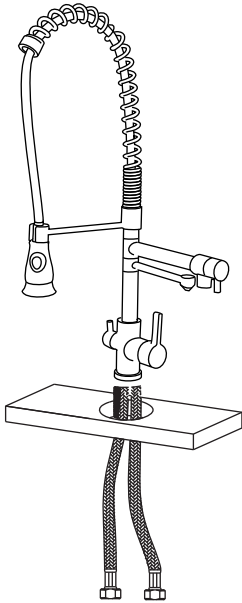

Step ⑤

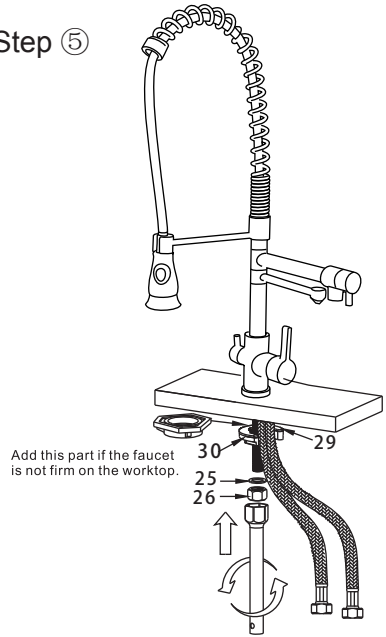

Step ⑥

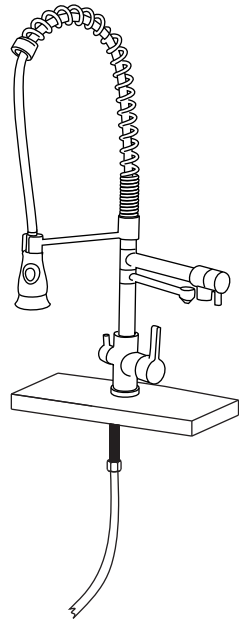
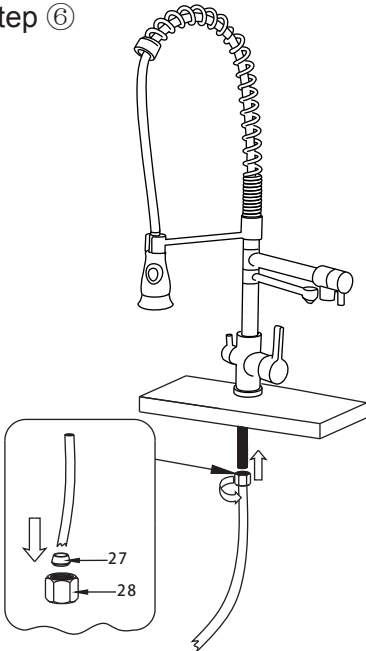

Step ⑦

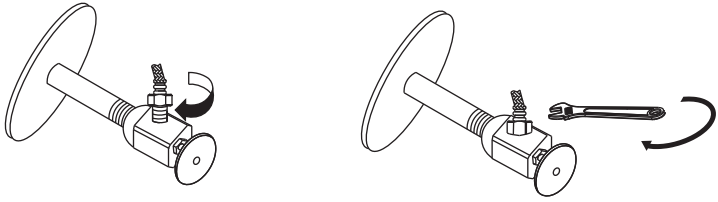

Step ⑧

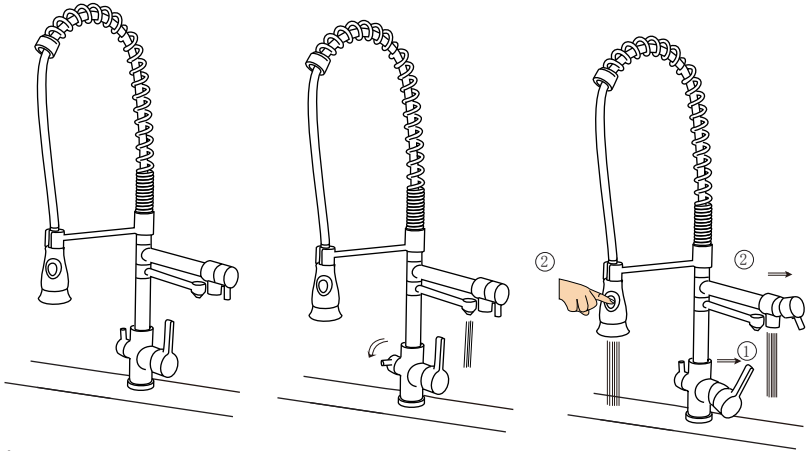

Notice:

Please removing all of the sand, silt and other things from the water hose before assembling, to avoid blocking the faucet and effecting water rate. Please use the special tools to disassemble it and wash with pneumatic equipment, if the faucet blocked.

Step ⑨

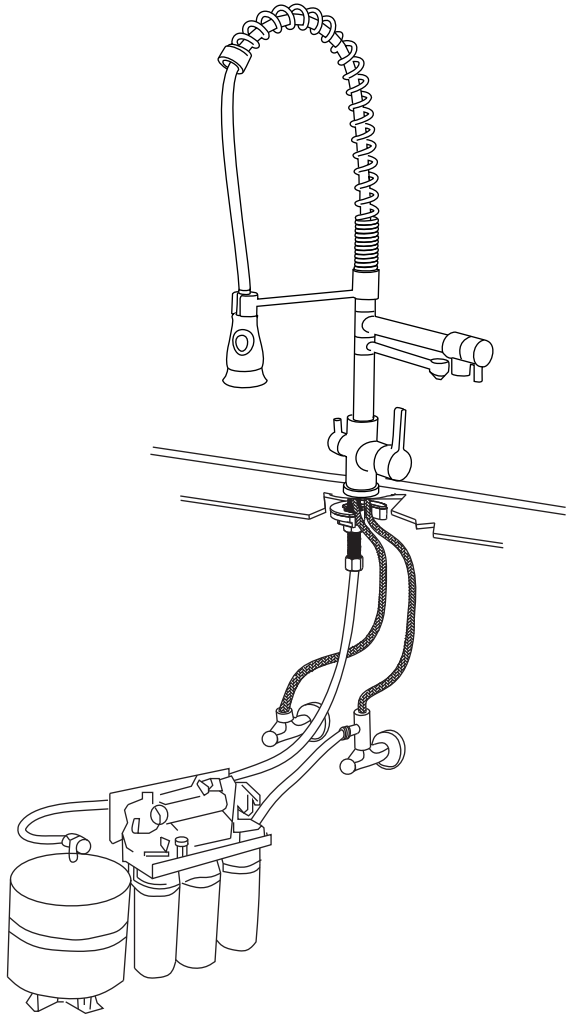

Step ⑩

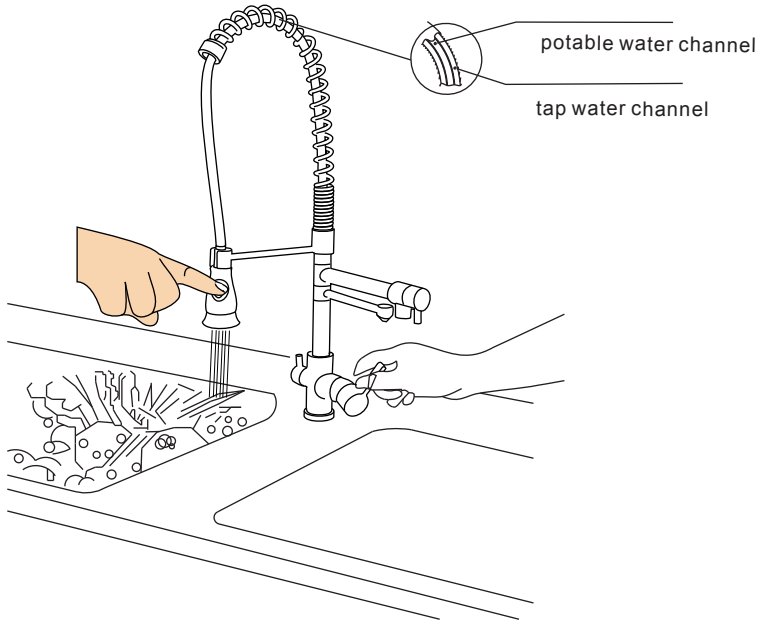

Step ⑩

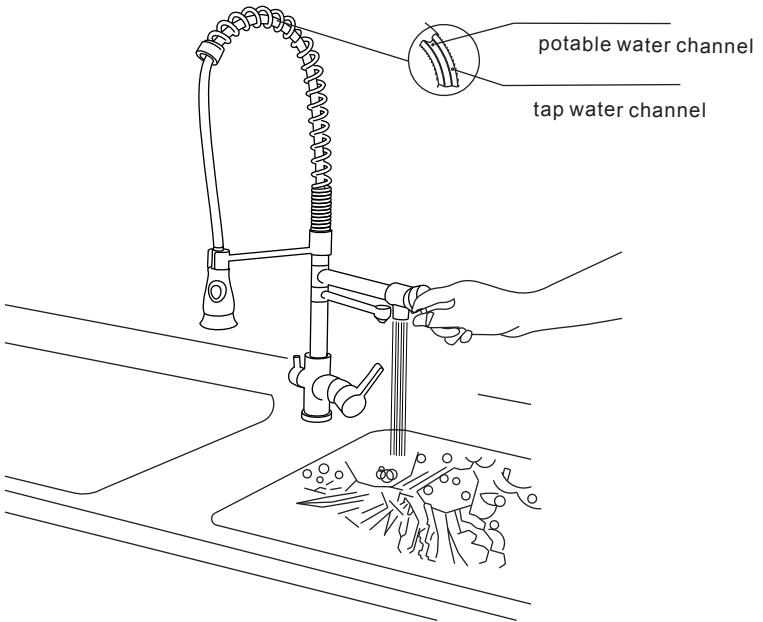

Step ⑪

